



USER GUIDE PLEASE READ CAREFULLY BEFORE USE



DOG

TRAINING COLLAR

GB 812

Thanks for choosing the Rechargeable and Waterproof Remote Dog Training Collar!

Our mission is to provide you with the safe tools to train your dog and we hope that this will fulfill your expectations!

This collar is a safe, comfortable and effective training system for all dogs that weigh over 15 lbs or 7 kg. Dogs who weigh 10 to 15 lbs (4,5 to 7 kg) can wear the collar, but do not use the shock function on dogs that weigh under 15 lb (7 kg), because it is too strong for them.

This system allows you to control your dog within a range of up to 1000 feet (300 m). The actual range may vary depending on terrain, weather, vegetation, battery capacity and radio signal interference.. The remote sends a signal to the collar and activates a beep, a vibration or a static shock at the press of a button. By using the training collar properly, you can correct a lot of your dog's undesired behaviour and teach basic and advanced obedience commands.

Contents

- 3 Features
- 3 How does the Training Collar work
- 4 Precautions
- 5 Components
- 6 How to install the belt to the Receiving Collar
- 7 Remote Overview
- 9 Step 1 Preparing the Remote
- Step 2 Preparing the Collar
- Step 3 Pairing the Remote and the Collar
- Step 4 Testing the Training Collar
- Step 5 Fitting the Collar on your dog
- How to use GoodBoy remote training collar
- 13 Frequently Asked Questions
- 15 Troubleshooting

Features

1. Rechargeable and weatherproof remote (can control up to two collars)
2. Rechargeable and waterproof collar
3. Up to 1000 feet (300 m) of remote control range
4. Beep Mode, Vibration mode or Shock mode.
5. Safety Mode: if the Launch button (Y) is held down for more than 8 seconds, the remote will enter Safety Mode to prevent potential harm to your dog. The buttons on the remote will become unresponsive and the screen will blink for 30 seconds.
6. Power saving modes:
 - The collar will go into Standby Mode if it's idle for more than 5 minutes and the green light will turn off. Moving the collar will reactivate it. Do not worry about the sound of rattling plastic. It is the standby sensor, which works by moving around inside.
 - The remote will go into Standby Mode if it's idle for 1 minute. Press any button to reactivate the remote.
7. Two pairs of metal contact points (short and medium) are included to suit the length of your dog's hair.
8. Two pairs of rubber contact point covers (short and medium) for if you do not wish to use the shock function.

NOTE: This collar is meant for active training of pets by their owners and it does not activate automatically.

Precautions

DO NOT use this product on aggressive dogs!

DO NOT touch the prongs when the device is turned on!

DO NOT use the shock function on dogs that weigh less than 15 lbs (7 kg).

DO NOT use high levels of shock on dogs over 15 lbs (7 kg) unless absolutely necessary.

DO NOT let your dog wear the collar unsupervised.

CAUTION: RISK OF SKIN DAMAGE FOR THE DOG

- Do not let your dog wear the collar for more than 8 hours per day.
- Gently reposition the collar on your dog's neck every 1 or 2 hours.
- Never attach a lead to the collar. This would cause excess pressure on the neck!
- When using a separate collar to connect the leash, please ensure that it does not put excess pressure on the remote collar.
- Examine your dog's neck daily for signs of chafing or soreness and regularly wash your dog's neck.
- If a rash or sore is found, stop using the collar until the injured skin has healed.
- If the condition persists for more than 48 hours, consult your local veterinarian.

Components

GB812

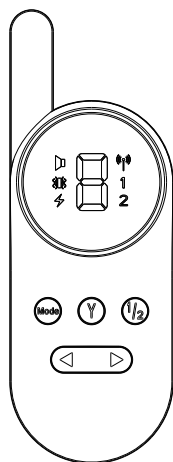

Remote Transmitter

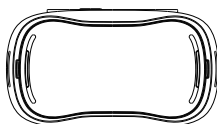

Receiving Collar



Mini Spanner

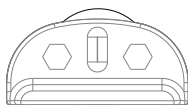

Test Light



USB Charging Cable



Contact Points

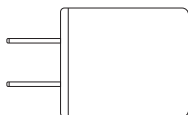

Adapter



Rubber Covers

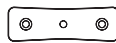

Plastic washer

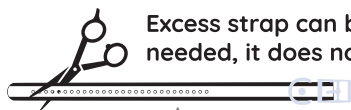

Excess strap can be cut if needed, it does not shred

Belt

How to install the belt to the Receiving Collar

1. Collar
2. Belt
3. Plastic washer
4. Contact points
5. Rubber contact point covers

Use mini spanner to secure the contact points to the collar.

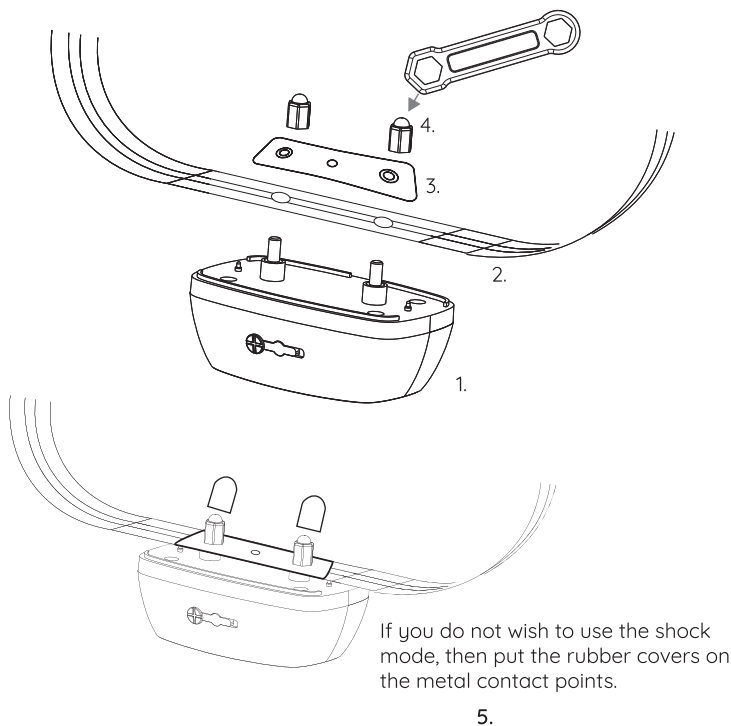

Remote Overview

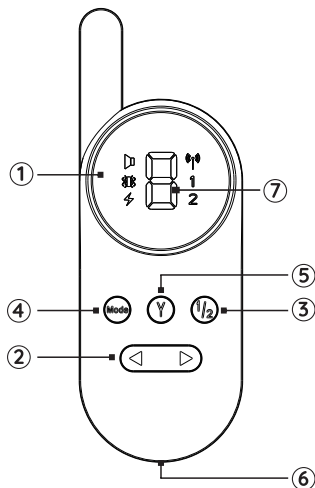

1. LCD screen
2. Intensity Up/Down button
3. Channel button
4. Mode button
5. Launch button
6. Charging port
7. Intensity level (1-9)

- Beep mode
- Vibration mode
- Static Shock mode
- Correction
- Channel 1
- Channel 2

LCD screen:

1.
 - Beep Mode: when this symbol is displayed, press the Y button to activate a Beep tone on the Collar.
 - Vibration Mode: when this symbol is displayed, press the Y button to activate vibration.
 - Static Shock Mode: when this symbol is displayed, press the Y button to activate static shock.
 - Correction: will turn on if the Y button is pressed and the remote is sending a signal to the collar. If the collar is paired, then the light will be active for the duration of the correction.
 - Channel 1: select this channel to control Collar 1
 - Channel 2: select this channel to control Collar 2

2. Intensity Up/Down: these are used to adjust the intensity of the vibration or shock from levels 1 to 9. The volume of the beep can not be adjusted.
3. Channel button: press this button to change between the 1st and 2nd Receiving collar.
4. Mode button: use this button to select the appropriate mode: beep vibration or static shock.
5. Launch button: activates the receiving collar in the selected mode.
6. Charging port
7. Intensity level (1 to 9)

* Lithium battery: 3.7V 500mAh for the remote and 3.7V 250mAh for the collar

* Operating frequency: 433 MHz

* Contact points: 2 pairs of metal contact prongs to suit the length of your dog's hair.

* Mini spanner: a tool to screw/unscrew contact points.

* Plastic washer: helps to keep the contact points in place.

* Rubber covers: 2 pairs of rubber contact point covers that can be used to avoid shock.

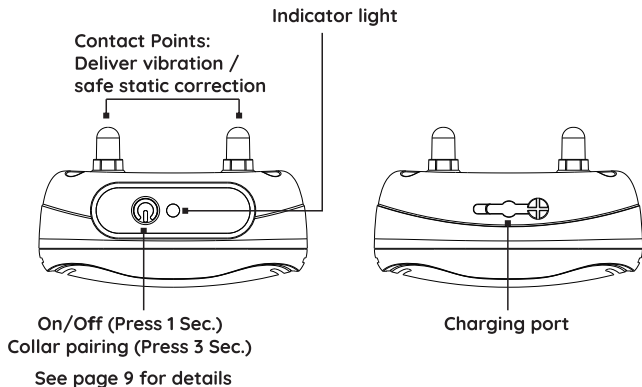

How to use GoodBoy remote training collar

STEP 1 - Setting up the remote:

Charge both the collar and the remote before use!





Please charge the product once a month if you are not actively using it to extend battery life.

Charging the Remote

1. Plug the USB charging cable into the charging port
2. Plug the Adapter into a standard outlet.
3. When charging, the number  on the LCD screen will be circulating.
4. Once the remote is fully charged, the LCD screen will display a dash (“-“). You can then remove the USB Charging Cable and close the charging port cover properly so that the remote is weatherproof.
It may take up to 2.5 hours for a full charge.

Low battery indicator: The LCD screen will display the letter “P” and flash for 30 seconds. After that, the remote will be turned off automatically.

How to use the Remote

1. Press any button to turn the remote on.
2. Use the Mode button to cycle through different modes. The LCD screen will display which mode is currently active (  .
3. Press the Intensity Up/Down ( ) buttons to set the intensity of the vibration or shock.
4. Select the appropriate channel (corresponding to collar 1 or 2).
5. Hold the remote horizontally and away from your body to achieve the optimal range. (The range may be affected by terrain features, weather, vegetation, transmission from other radio devices and other factors.)
6. Press the Y button to activate the chosen mode. The correction lasts as long as the button is held down or until 8 seconds has passed.

STEP 2 - Setting up the collar:

Charging the Collar:

1. Remove the rubber cover and plug the USB cable into the charging port.
2. Plug the adapter into a standard outlet.
3. The collar is fully charged when the red LED turns green.
It may take up to 1.5 hours for a full charge of the collar.
4. Remove the cable. Remove the cable and close the charging port cover.
Make sure that the cover is closed properly so that the collar is waterproof.
5. Press the ON/OFF button to turn the collar on.
The green LED will indicate that the receiving collar is ON.

Low battery indicator: The red LED on the receiver will blink for 30 seconds. After that, the receiving collar turns off automatically - please recharge the receiving collar.

STEP 3 - Pairing the remote and the collar:

1. Press any button to turn on the remote.
2. Press the channel (1/2) button to choose either channel 1 or 2.
3. Hold the ON/OFF button on the collar for 3 seconds. The green LED on the collar will start blinking. This indicates, that the collar is ready for pairing. Then on the remote, choose the desired channel for pairing (1 or 2). Press the Y button on the remote to assign the currently active collar (green blinking LED) to the selected channel. The green LED on the collar will stop blinking and turns on, indicating that the collar has been paired successfully.
4. To pair the second collar or to pair the collar to another channel, repeat points 1 to 3. When pairing a second collar, make sure you switch to a new, unused channel before pairing.

Warning: To avoid assigning two collars to the same channel, wait at least 10 seconds before testing (see previous step).

STEP4 - Testing the collar:

Note: make sure you have paired the collar(s) before testing (see previous step)

🔊 Testing the Beep Function

- Press the Mode button on the remote to select Beep Mode
- Press the Y button on the remote. If the collar beeps, the Beep Function is working properly.
- The volume of the beep can not be adjusted

📡 Testing the Vibration Function

- Press the Mode button on the remote to select Vibration Mode. The intensity of the vibration can be adjusted by pressing the Intensity Up/Down button from and choosing a level from 1 to 9.
- Press the launch (Y) button on the remote. If the collar vibrates, the vibration function is working properly.

⚡ Testing the shock function

Caution: Do not touch the metal contact points with bare hands when the shock mode is activated and the collar is turned on!

The static impulse generated by the collar can not be seen nor heard. Test whether the shock function works by using the following procedure:

- Remove the test light from the package and connect it to the contact points on the collar.
- Press the “Mode” button on the remote to select Shock mode.
- Shock intensity can be adjusted with the Up/Down button from level 1 to 9.
- Press the Y button on the remote. If the test light flashes, then the Shock Mode is functioning correctly.

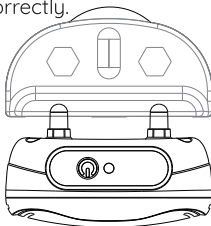

STEP 5 - Fitting the collar on your dog.

Important: The correct fitting and placement of the collar is important for the effective functioning of the system and the successful training of your dog. The contact points must touch the skin on the underside your dog's neck.

Follow these steps to ensure, that the collar is fitted correctly:

1. Let your dog stand (NOT SIT) comfortably in front of you. (Picture A)

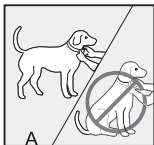

2. Place the contact points to the center of your dog's neck and make sure they touch the skin. Use longer contact points if your dog has long hair or a thick coat. You might have to trim your dog's hair a bit for better contact. The highest vibration or shock level can penetrate up to ¼" (6 mm) of fur. If you do not wish to use the shock function, then put the rubber covers on the contact points.
3. After finding the perfect fit, take the collar off, put the plastic washer in between the contact points and the collar and tighten the contact points with the spanner.



remote.goodboytraining.com

The tutorial video can be found by following either of the links above.

Frequently Asked Questions

How old does my dog have to be before I start using the remote collar?

Your pet should be able to recognize basic commands such as “Sit!” and “Stay! The collar may be too large for dogs that weigh less than 15 lbs or 7 kg, but it is possible for some 10 to 15 lb (4.5 to 7 kg) dogs to wear it without issues.

Once my dog is trained and has learned to obey my commands, will he have to continue wearing the collar?

Probably not. Although from time to time you may need to reinforce the training with the help of the collar.

Can I use two remotes with one collar?

No, a collar can be paired to only one remote at a time.

Can I use the collar with more than one dog?

Yes, you can easily pair a second remote controlled collar to the system. The second collar can be paired to the second channel on the remote.

Will I get exactly 1000 feet (300 m) of range between the remote and the collar?

The effective range is up to 1000 feet (300 m) without obstacles and other interference. The actual range may vary depending on terrain, weather, vegetation, battery capacity and radio signal interference.

Is the collar waterproof?

Yes! In fact, your dog can swim with the collar on. However, make sure that you carefully re-seal the charging port cap after charging the collar! The remote, however, is only weatherproof. It can handle light rain, but do not submerge it in water.

What should I do if my dog’s neck becomes red and irritated?

Remove the collar and do not use it on your dog for a few days. If the irritation persists for more than 48 hours, consult your local veterinarian.

Once the skin returns to normal, you can use the collar again, but you should loosen the collar a bit (not too loose or it will not work) and give your dog more breaks from wearing it. Monitor your dog’s skin closely; stop using the collar if the irritation persists.

Can I attach a leash to the collar?

No! This will result in the contact points being pulled too tightly against the dog's neck. If you need to keep your dog on a leash, then use a separate NON-METALLIC collar.

How will I know when to charge the Remote or Collar?

The remote needs to be charged when the LCD screen displays the letter "P" which flashes for 30 seconds and after which the remote turns off automatically.

The collar needs to be charged when the red LED light on the collar blinks for 30 seconds and after which the collar turns off automatically.

What is the lifespan of the lithium batteries?

The lithium batteries in the remote and the collar can be charged for up to 400 times. The average duration of a charge is, depending on use, about a week.

For how long can I leave the collar on my dog?

No more than 8 hours per day, because the collar was not designed to be kept on for longer than that.

How long should the dog training sessions be?

The training sessions should be kept short to achieve maximum effectiveness. It is not advised to train your dog for more than 10-15 minutes at a time.

What kind of dogs are the collars suitable for?

This product is not suitable for dogs with necks larger than 26 inches (66 cm) or for dogs that weigh less than 15 lbs or 7 kg. Dogs who weigh 10 to 15 lbs (4,5 to 7 kg) can wear the collar and use the sound and vibration functions, but the shock mode is not to be used on them.

The collar's length is adjustable from 11 to 26 inches (28 - 66 cm). If your dog's neck is smaller than 26 inches (66 cm), then please cut the excess strap.

Why does the collar make a rattling sound as if something is loose inside?

That is the standby sensor which moves around inside the collar and when it stops moving, the 5-minute countdown to Standby Mode begins.

Troubleshooting

I have fitted the collar correctly, but my dog is not responding.

- Ensure that the batteries are fully charged. You need to charge both the remote and the collar fully before first use.
- Make sure that the contact prongs are touching your dog's skin. Ensure that you are using the correct set of prongs suitable for the length of your dog's fur. You might have to trim the fur from where the contact prongs should touch the skin.
- Make sure the collar you are trying to activate is paired with the remote. See page 9 for instructions.
- Make sure the correct channel is selected on the remote.
- Increase the impulse intensity. If necessary, try going up a mode (from Beep to Vibration to Shock).
- Restart the collar by pressing the On/Off button.
- Perform the test sequence as described on page 10
- If none of the above works, contact us at **support@goodboytraining.com** and we will provide further assistance.

The Remote Transmitter does not work

- Charge the remote before first use. The charging time is typically 2.5 hours.
- The remote will automatically go into Standby Mode if it is idle for 1 min and its screen will turn off. Press any button to reactivate the remote.

Contact us and we will send you a free replacement if:

- The battery charge lasts less than a day.
- The collar unpairs all the time.
- The shock function does not work even if the battery is full and the contact points touch the skin.
- The sound or vibration functions do not work.
- The remote or collar do not turn on even after charging.
- The Collar does not come out of standby mode when dog moves.
- Anything is missing from the package.
- Other technical difficulties arise.



Please feel free to contact us at
support@goodboytraining.com

Products for
pets people *love*